

Owner's Manual

Split type wall mounted
air-conditioner



- ※ Please read this owner's manual carefully and thoroughly before operating the unit!
- ※ Take care of this manual for future reference.

CONTENTS

Safety Precautions	1
WEEE Warning	4
Name Of Each Part	5
Operation	6
Notices	7
Care and Maintenance	8
Troubleshooting	8
Installation Guide	10
Selection of the installing position	11
Installation of the indoor unit	12
Installation of the outdoor unit	13
Pipe connection	14
Electrical connection	16
Test running	18
Packing list	18

Safety Precautions

Incorrect operation due to ignoring instruction will cause harm or damage. The seriousness is classified by the following indications:



WARNING

This symbol indicates the possibility of death or serious injury.

CAUTION

This symbol indicates the possibility of injury or damage to properties only.

WARNING

1. This appliance can be used by children aged from 8 years and above and persons with reduced physical, sensory or mental capabilities or lack of experience and knowledge if they have been given supervision or instruction concerning use of the appliance in a safe way and understand the hazards involved. Children shall not play with the appliance. Cleaning and user maintenance shall not be made by children without supervision. (Only for the AC with CE-MARKING)
2. This appliance is not intended for use by persons (including children) with reduced physical, sensory or mental capabilities, or lack of experience and knowledge, unless they have been given supervision or instruction concerning use of the appliance by a person responsible for their safety. Children should be supervised to ensure that they do not play with the appliance.  (Except for the AC with CE-MARKING)
3. The air conditioner must be grounded. Incomplete grounding may result in electric shocks. Do not connect the earth wire to the gas pipeline, water pipeline, lightning rod, or telephone earth wire.
4. Don't pull out the power plug during operating or with wet hands.  It can cause electric shock or fire.
5. The appliance shall be installed in accordance with national wiring regulations.

6. Don't pull the power cord when pull out the power plug.

The damage of pulling power cord will cause serious electric shock.



7. The power plug must be inserted tightly.

Otherwise, it can cause electric shock or overheating, even fire.



8. Don't share the socket with other electric appliance, and use the broken or unstandord cord.

Otherwise, it can cause electric shock even fire.



9. Clean the dust on the plug regularly.

Otherwise the dust mixed, humidity will result in insulation fault even fire.



10. An earth leakage breaker with rated capacity must be installed to avoid possible electric shocks.



11. Cut off the main power switch when not using the unit for a long time. Otherwise, it may cause product failure or fire.



12. Stop operation and cut off the main power in storm or hurricane. Operation with windows opened may cause electric shock.

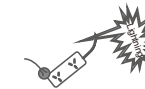

13. Don't install air conditioner in a place where there is flammable gas or liquid. The distance between them should above 1m. It may cause fire.



14. Don't put a finger, a rod or other object into the air outlet or inlet.

As a fan is rotating at a high speed, it will cause injury.



15. Don't touch the swinging wind vanes.

It may clamp your finger and damage the driving parts of the wind vanes.



16. Don't attempt to repair the air conditioner by yourself.

You may be hurt or cause further malfunctions.



17. Take care not let the remote control and the indoor unit watered or being too wet, or may short circuit even caused fire.



18. Don't use liquid or corrosive cleaning agent wipe the air-conditioner and sprinkle water or other liquid either.

Otherwise the inclosure will be damaged even electric shock.



19. If the power supply cord is damaged, it must be replaced by the manufacture or its service agent or a similar qualified person.

CAUTION

1. Don't install the indoor unit under sunshine directly.
2. Don't block air inlet or air outlet, otherwise, the cooling or heating capacity will be weakened, even cause system stop operating.
3. Don't apply the cold air to the body for a long time. It will deteriorate your physical conditions and cause health problems.
4. Close the windows and doors, otherwise, the cooling or heating capacity will be weakened.
5. If the air filter is very dirty, the cooling or heating capacity will be weakened. Please clean the air filter regularly .
6. It was prohibited to stand or put things onto the top of the outdoor, to avoid drop or damage. In no case should children be allowed to sit on the outdoor unit.
7. Set the suitable temperature, especially there are old people, children and patients in the room. Generally, keep the temperature difference for 5°C between the inside and outside.
8. In case that the unit occurs closing down due to the severe interference from outer environments such as mobile phone, please cut off the plug and plug in to restart the air conditioner after several seconds .
9. It is forbidden to let the air conditioner keep precision instrumentation, artistic production for long time and make food fresh, otherwise abnormal using will cause damage and weaken.
10. It is forbidden to let children and the disabled use air-condition without other adult checking.
11. Open windows frequently after using air-condition for a long time.
12. If your air conditioner is not fitted with a supply cord and a plug, an all-pole switch must be installed in the fixed wiring and the distance between contacts should be no less than 3.0 mm.
13. If your air conditioner is permanently connected to the fixed wiring and have a leakage current that may exceed 10 mA. Leakage protector must be installed in the fixed wiring.
14. The power supply circuit should have leakage protector and air switch of which the capacity should be more than 1.5 times of the maximum current.
15. If the **equipment** emissions cannot meet the technical requirement of IEC 61000-3-3, **following** Attention should be take care.

Attention!

This appliance can be connected only to a supply with system impedance no more than Z_{max} . In case necessary, please consult your supply authority for system impedance information.

Product Type	Z_{max}
ASW-H18E1A4/#R1-C5	0.395
#= SA,SC,SD,SE,SF,SP,SQ,SR,SO,SS,ST,SV,SQC,SL,SW,SG,SH,SU,SK,VA,VH,SUA,SUC,SUD,SUV,SUE,SUG,SUK,SUN,SUP,SUL, SUQ,SUR,SUT,SUX,QB,EW,EL	
ASW-H24F8A4/#R1-C5	0.284
#=SA,SC,SD,SE,SF,SP,SQ,SR,SO,SS,ST,SV,SQC,SL,SW,SG,SH,SU,SK,VA,VH,SUA,SUC,SUD,SUV,SUE,SUG,SUK,SUN,SUP,SUL,SUQ,SUR,SUT,SUX,EA-EC,EE-EQ,ES-EZ, EAA,EAB,EAC,EAD,EQB,EQC,EYK,EXA,ESK,QF,QA,QB,QC,QD,QN	

WEEE Warning

Meaning of crossed out wheeled dustbin:

Do not dispose of electrical appliances as unsorted municipal waste, use separate collection facilities.

Contact you local government for information regarding the collection systems available.

If electrical appliances are disposed of in landfills or dumps, hazardous substances can leak into the groundwater and get into the food chain, damaging your health and well-being.

When replacing old appliances with new ones, the retailer is legally obligated to take back your old appliance for disposals at least free of charge.

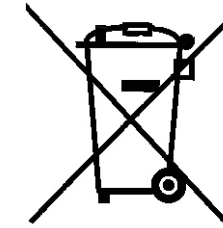

Name of Each Part

★ **Indoor Unit**

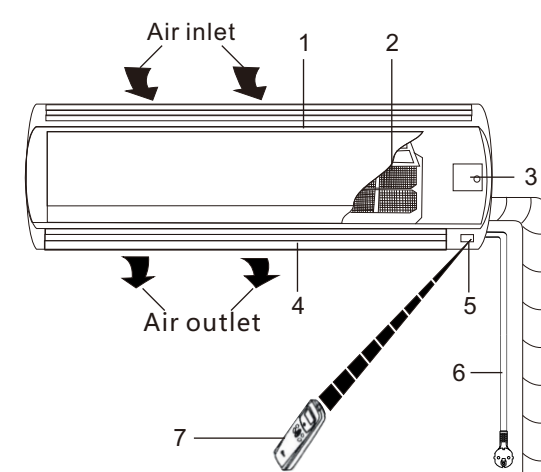

Indoor Unit

- 1、 Front panel
- 2、 Air filter
- 3、 Handling switch
- 4、 Louver
- 5、 Signal receptor
- 6、 Supply cord
- 7、 Remote controller
- 8、 Drain hose
- 9、 Refrigerant gas/ liquid pipe

★ **Outdoor Unit**

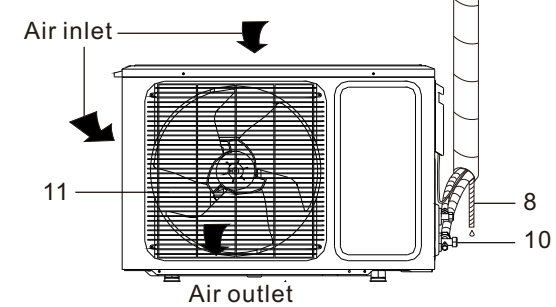

Outdoor Unit

- 10、 Cut-off valve
- 11、 Air outlet cover

Note:

- 1.If the power supply from outdoor unit, you can find the power supply card is fitted in the outdoor unit.
- 2.The descriptions in this user manual are text and figures may have slightly difference to the promotion information and actual appliance. Please refer to the real appliance purchased. Thank you.

Operation

★ Remote controller operation

See "air conditioner remote controller instruction "

★ Manual operation

☆ Manual operation

When the remote controller does not work or can not be found, please follow these steps:

- 1.As the unit is operating, you can press the "Auto button" to stop operating.
- 2.As the unit is stopping, you can press the "Auto button" to start operating.

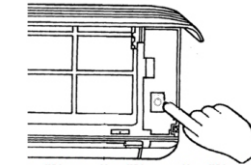

☆ Adjusting air flow direction

1.Adjusting horizontal air flow manually.

Use your hands to move the vertical airflow vane and change the horizontal wind direction.

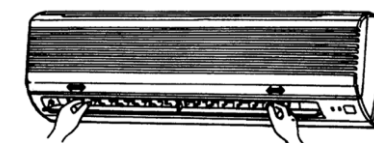

⚠ Note:

- a. Adjust the horizontal air flow direction before the air-conditioner starts. Don't insert your finger into air intake or outlet vents when the air-conditioner is operating.
- b. For appliance with auto pendulum wind function, please refer to "air conditioner remote controller instruction " for how to adjust horizontal air flow.

2. Adjusting vertical air flow direction(up-down)

Refer to "air conditioner remote controller instruction "for how to adjust vertical airflow direction through adjusting the horizontal airflow vane by remote controller.

⚠ Note:

- Adjust the vertical air flow direction by remote controller. When you adjust the horizontal airflow vane by hand, the machine may cause problem.
- Manual operation can be used temporarily in case you can not use remote controller or its batteries are exhausted.
- When the air-conditioner stops, the horizontal wind vane will close the wind outlet of air conditioner.

Notices

To prevent injury and property damage, Please pay attention to these following before operating the air conditioner.

★ Checking before operation

1. Make sure that the earth wire is connected safely and reliably.
2. Make sure the filter net is properly fixed.
3. Make sure that air outlet and inlet are not blocked.
4. Please clean the filter before starting the air-conditioner referring to page to 6 "Cleaning" for how to operate.
5. Check to see whether the outdoor install bracket is damage. If yes, please contact our Service center locally.

★ Safety tips

In order to use the air conditioner properly, please refer to its working temperature range. Otherwise, indoor unit automatic protection function may be activated, cooling or heating efficiency will be weakened.

The air-conditioner may can't run in normal followed under mentioned table

Cooling	Outdoor	>43℃(Apply to T1)
		>52℃(Apply to T3)
	Indoor	<18℃
Heating	Outdoor	>24℃
		<-7℃
	Indoor	>27℃

Note: T1 and T3 refer to ISO 5151.

★ Notices for R410A models

N 842/2006 : If the air conditioner you bought used the refrigerant R410A, the amount of refrigerant is in a closed cooling circuit. The coolant does have zero ozone depletion potential, but is a so-called greenhouse gases under the Kyoto Protocol and may thus contribute to global warming, if it is released to the atmosphere. Therefore only trained technicians with refrigerant certificate make a filling or emptying.

GWP: R410A(R32/125:50:50):2088

Care and Maintenance

★ Cleaning

☆ Cleaning the indoor unit

1. Turn off the air-conditioner and remove the electrical plug from the outlet.
2. Wipe the indoor unit with dry cloth or wet cloth which is dipped by cold water.

⚠ Note :

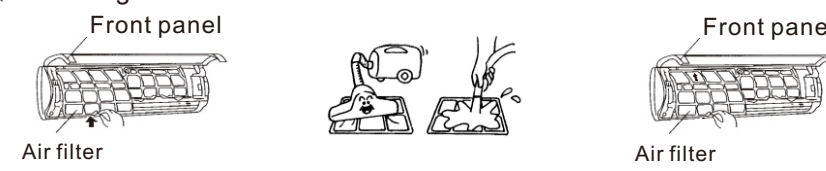

- Don't use water above 45°C to wash the panel, or it could cause deformation or depigment.
- Don't use thinner, polishing powder, benzene and other volatile chemicals.
- Don't use liquid or corrosive detergent clean the appliance and don't splash water or other liquid onto it, otherwise, it may damage the plastic components, even cause electric shock.

☆ Cleaning air filter



1. Raise up the front panel of indoor unit until it suddenly stop, then raise up the protruded part of air filter, and then take it out.
2. Use a vacuum cleaner or wash them with water, then dry it in the shade.
3. Reinsert the air filter into the indoor unit until being entirely fixed, then close the front panel.

★ Maintenance

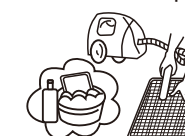
1. Select "FAN" operation mode, make the air conditioner run a long time to dry. 
2. Turn off the air conditioner and cut off the power supply. 
3. Take out the batteries from the remote controller. 
4. Clean air filters and other parts. 

Troubleshooting

Check the following before requesting on service centre if the malfunction occurs.

Phenomenon	Trouble shooting
Air conditioner dose not operate at all	<ul style="list-style-type: none"> ● Has the power been shut down? ● Is the wiring loose? ● Is the voltage higher than 1.1 times of max rated voltage or lower than 0.9 times of min rated voltage? ● Is the fuse burnt? ● Does it reach the set time for start up?

Phenomenon	Troubleshooting
Remote controller is not available	<ul style="list-style-type: none"> ● Is the remote controller out of effective distance to the indoor unit? ● Is the battery exhausted? ● Are there any obstructions between the controller and the signal receptor?
Cooling (Heating) efficiency is not good	<ul style="list-style-type: none"> ● Is the setting temperature suitable? ● Is the air inlet or outlet obstructed? ● Are air filter dirty? ● Is indoor fan speed set at low speed? ● Is there any heat source in your room?
Indoor unit does not operate immediately when the air conditioner is restarted	Once the air conditioner is stopped, it will not operate in approximately 3 minutes to protect itself.
There is unusual smell blowing from the outlet after operation is started.	This is caused by the odour in the room permeated from building material, furniture, or smoke.
Sound of water flow can be heard during cooling operation	This is caused by the refrigerant flowing inside the unit.
Mist is emitted during cooling operation.	Because the air of the room is cooled down rapidly by the cold wind and it looks like the fog.
Mist is emitted during heating operation.	This generate due to moisture in defrosting process.
Low noise can be heard during operation	<ul style="list-style-type: none"> ● A low hissing sound is caused by the refrigerant flowing. ● A low squeak sound is caused by the deformation of plastic due to temperature.

In case the following situation, please immediately stop all operations and cut off the power supply, then contact with service centre.

- The fuse and switch often breaks.
- Carelessly splash water or something into air conditioner.
- Unusual noise can be heard during operation.
- Electrical wiring and power plug are very hot.
- Wind blowing from the outlet smells terrible during operation.
- The Run light or other display flashes rapidly and keeps flashing after replugging.

Installation Guide

★ Guide for customer

1. Please read the instructions carefully before installation of the air-conditioner.
2. The installation should be carried out by specialists.
3. Installation the air-conditioner and connecting the pipe and wires must be strict to reference the instructions.
4. The wiring must be done by qualified electrician according to the electrical safety requirements.
5. The customer should have a qualified power supply which coincides with the tag of air conditioner, the normal voltage should be in the range of 90-110% of its rated voltage.
6. The air conditioner must be well grounded, the switch of the main power of air-conditioner must be reliably grounded.

★ Notices

1. The air conditioner must be installed on well strong supporter.
2. The appliance shall be installed in accordance with national wiring regulations.
3. Fix the machine firmly, otherwise it will produce abnormal noise and vibration.
4. Install the outdoor unit in the place where it wouldn't disturb your neighbour.
5. The method of connection of the appliance to the electrical supply and inter connection of separate components, please see the electric connection elements shart which stick on the machine.
6. After installation, the power plug should be easily reached.

Selection of the installing position

★ Indoor Unit

- There is no heating and steaming source nearby.
- No obstacles for installing position nearby.
- Keep good air circulation.
- Convenient to adopt measures to reduce noises.
- Do not install them near the doorway.
- Make sure to have the distance between the ceiling, wall, furniture and other obstacles.
- 2 meters high above the floor.

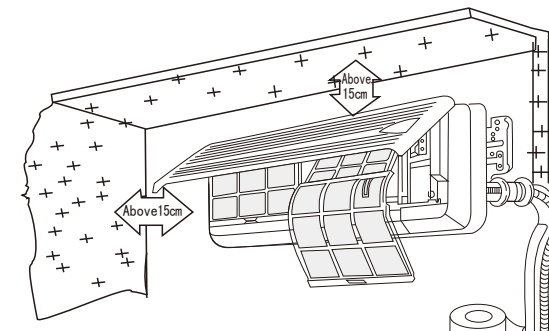

★ Outdoor Unit

- In case that you put up a canopy to protect it from rains and sunrays, pay attention not to cause any obstacles for the heating dispersion for the condenser.
- Do not grow animals or plants near the installation location for the cold and hot air out will affect them.
- Make sure to have the distance specified in the picture between ceiling, wall, furniture and other obstacles.
- Stay away from heating source and inflammable air.
- The installation base and supporting frame should be strong and secure. The machine should be at plane surface.

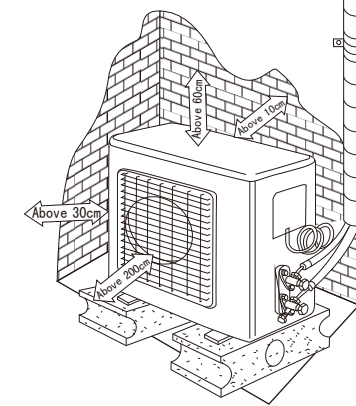

The distance between indoor and outdoor unit should be 5 meters and pipe length can go up to maximum 15 meters with additional refrigerant charge.

Max. Allowable Tubing Length at Shipment(m)	Limit of Tubing Length(m)	Limit of Elevation Difference H(m)	Requires Amount of Additional Refrigerant (g/m)	
			CC≤12000Btu	CC>18000Btu
5	15	5	20	30

Installation of the indoor unit

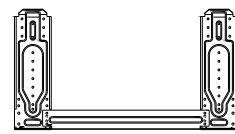

● First make changes to wall and make sure that is hard and secure. Using four "L" type screws to fasten the installation board onto the wall. Keep it water level horizontal direction and perpendicular in vertical direction. Otherwise it might cause water drops when air-conditioner is running cooling operation.

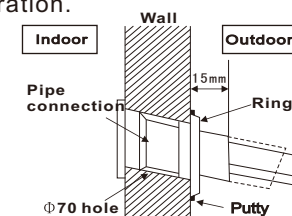
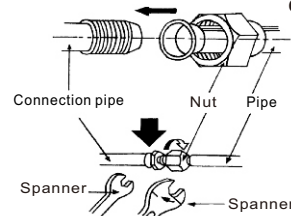

● Drilling 70mm diameter pipe hole at the left down or right down side of the installation board. The hole shall slant outward slightly.

● Pull out the indoor unit pipes after detached the fixed parts on them. Connect the interconnected pipes to the indoor unit: point to the center of pipe and fasten the connection screw at first by hand and then by wrench until you hear the "Click" sound. Fastening direction is shown in the right picture. Using torque is shown in the following table.

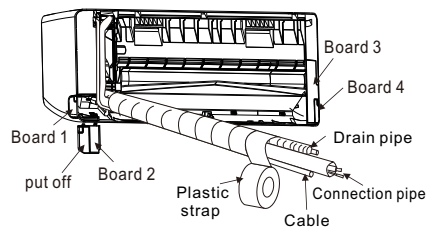

● Before installation, confirm connection pipes' direction. Remove the board 1 and board 2 on the correct connecting side. Press connection pipes to the board gap, then install board 2 to the original location. If connection pipes are on the other side, install them as above.

Dural drainage feature AC can be installed as below chart shows:

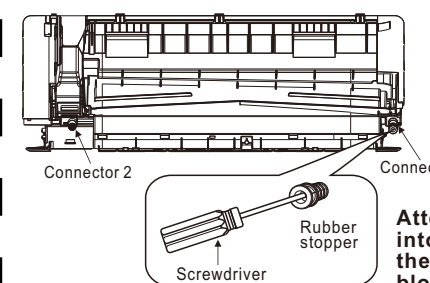

● Drainage pipe can be connected to the connector 1 and connector 2. If it's necessary to adjust drainage pipe to the other connector, remove rubber stopper from this side and fix drainage pipe to it, then fix the rubber stopper to the other connector to make it blocked up.

Attention: Please use tools like screwdriver to insert into the back hole of the rubber stopper and plug it to the connector when you want to make the connector blocked up.

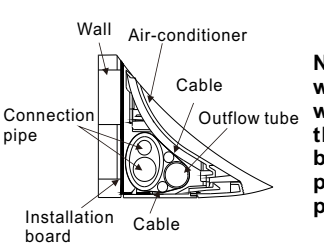

Note: The installed air-conditioner won't be tightly appressed to the wall if that is not arranged shown in the picture. The outflow tube must be in the bottom and the highest point of it can not exceed the position of water basin.

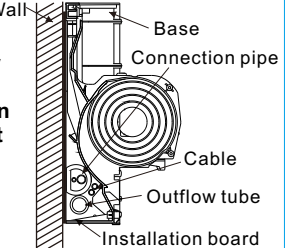

★ **Check the water discharge**

1. Take off the frame the unit cover.
Take off the front frame for maintenance according to the following steps:

- Turn perpendicular airflow direction handle from "I" to horizontal direction.
- As shown in the picture on the right, take off two covers from the front frame and then unfasten two fixture screws.
- Pull the front frame towards yourself and take it off.

In case that put the front frame back, turn the perpendicular airflow direction handle from "I" to horizontal, then proceed according to the third and the second steps.

You should check whether the front frame is firmly inside the fixture groove on the top.

2. Check the water discharge.

- Put a cup of water into groove.
- Check whether the water flow through the water discharge hole.

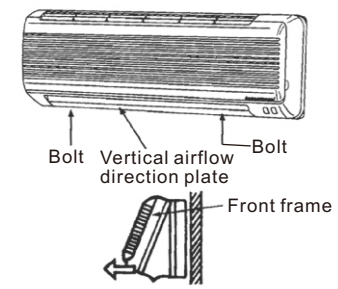

Pull down the front frame towards your and take off the front frame.

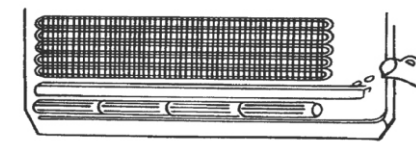

Installation of the outdoor unit

- The outdoor unit must be firmly fixed to avoid falling in the strong wind.
- Install on the cement base the drawing below.
- If it will be installed at seaside or at a place high above the ground and with strong wind, the AC should be installed against the wall to ensure the normal operation of the fan and the blocking plate should be used.
- If it will be installed in type, the structure of the mounting surface should be made of solid stick, cement or materials with equivalent strength, and be of enough bearing capacity. Otherwise, measures such as reinforcement, support or vibration damping should be adopted.

Installation outdoor unit bolt

Outdoor Unit Size of Shape W1(W2)×H×D (mm)	A (mm)	B (mm)
665(710)×420×280	430	280
600(645)×485×260	400	290
660(710)×500×240	500	260
700(745)×500×255	460	260
730(780)×545×285	540	280
760(810)×545×285	540	280
790(840)×550×290	545	300
800(860)×545×315	545	315
800(850)×590(690)×310	540	325
825(880)×655×310	540	335
900(950)×700×350	630	350
900(950)×795×330	535	350

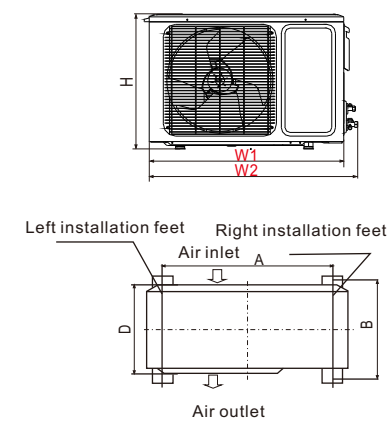

Outdoor Unit

Pipe connection

- Connect the pipe to the unit: point to the center of pipe and fasten by wrench until it is tightly fastened, the fastening direction is in the following picture.

The size of pipe	Torque
Φ 6.35mm ($\frac{1}{4}$ ")	18N.m
Φ 9.52mm ($\frac{3}{8}$ ")	42N.m
Φ 12.7mm ($\frac{1}{2}$ ")	55N.m
Φ 15.88mm ($\frac{5}{8}$ ")	75N.m

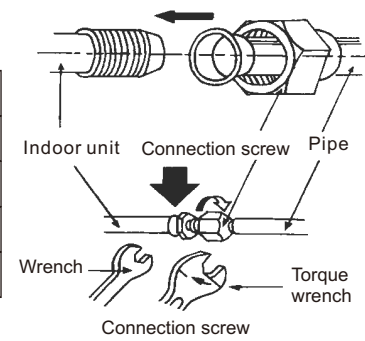

- Pointing towards the center of pipe, fasten the screw with strength.
- Wrench the screw in the end until you hear the "Click" sound.

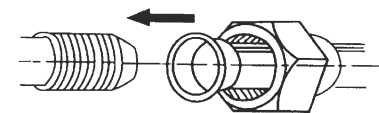

Refer the direction to the picture

★ The form of pipe

Use sealing tape to cover the small leaks on the external ring of the pipe

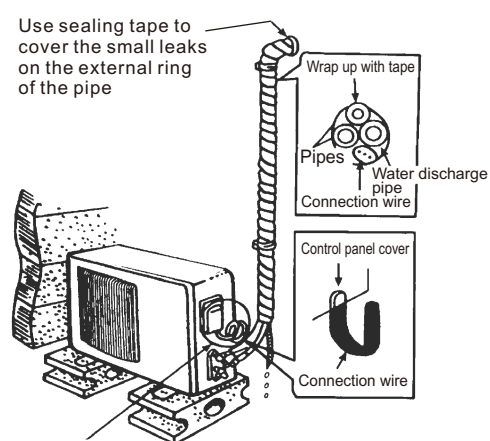

Round in this shape to prevent water entering the electrical parts

- Wrap up all pipe, water discharge and connection wire from top to below.
- Cover the connection and fix them with two plastic rings.
- Wrap up the pipes with tape alongside the wall and fix them to the wall with clips. These steps are usually adopted when outdoor unit is installed below the indoor unit.

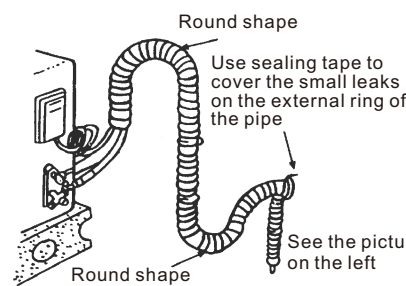
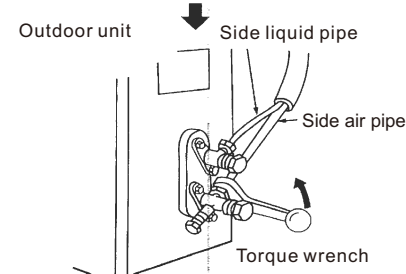

- In case that you want to have additional water discharge pipe, the end of pipe should be within certain distance towards to surface (don't let it under the water. Fix it onto the wall so it won't be swayed by the wind).
- Wrap the pipes and connection wire well from below to top.
- Wrap up the pipes that are rounded up by the wall comers in the way shown in the picture so it can prevent water entering the room.
- Use clips or other fixture to fasten the pipes to the walls.

★ **Expelling the air in the pipes and the indoor unit**

Expelling the air: humid air in the refrigerating system might cause trouble of compressor.

- Take off the cover from the stop valve and T-branch valve.
- Take off the auxiliary cover from the T-branch valve.
- Turn the stop valve rod anti-clock wise to an angle of 90 degree, keep it open for 8 seconds and close the valve.
- Check whether there is air leakage at all connection parts of pipes.
- Push the top rod of T-branch valve by hexagon wrench to expel air.
- Repeat the third and fifth steps.
- Open the stop and T-branch valve with a hexagon wrench to make the unit operate.
- There is no leakage allowed, please check all the piping connection parts. You must test the leakage, generally, it can be tested by soap water.

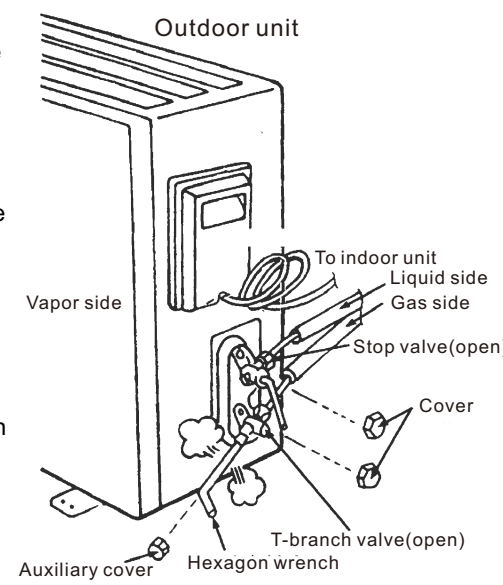

● **If the A/C is filled with R410a, make sure to discharge air and moisture remaining in the refrigerant system with a vacuum pump.**

(For method of using a manifold valve, refer to its operation manual.)

1. completely tighten the flare nuts, A, B, C, D, connect the manifold valve charge hose to a charge port of the low-pressure valve on the gas pipe side.
2. Connect the charge hose connection to the vacuum pump.
3. Fully open the handle Lo of the manifold valve.
4. Operate the vacuum pump to evacuate. After starting evacuation, slightly loose the flare nut of the Lo valve on the gas pipe side and check that the air is entering (Operation noise of the vacuum pump changes and a compound meter indicates 0 instead of minus.)
5. After the evacuation is complete, fully close the handle Lo of the manifold valve and stop the operation of the vacuum pump. Make evacuation for 15 minutes or more and check that compound meter indicates $-76\text{cmHg}(-1 \times 10^4 \text{Pa})$.
6. turn the stem of the packed valve B about 45° counterclockwise for 6~7 seconds after the gas coming out, then tighten the flare nut again. Make suer the pressure display in the pressure indicator is a little higher than the atmosphere pressure.
7. Remove the charge hose from the Low pressure charge hose.
8. Fully open the packed valve stems B and A.
9. Securely tighten the cap of the packed valve.

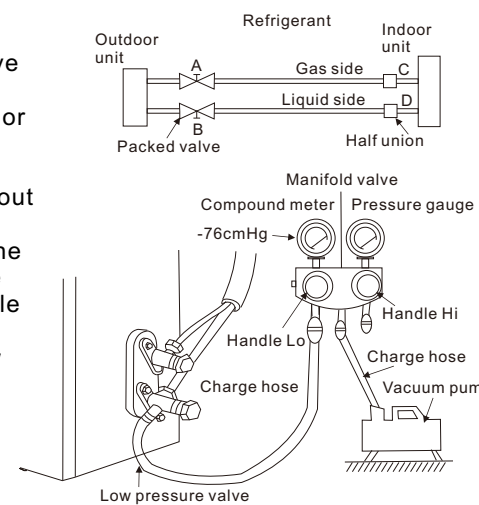

Electrical connection

The connection cables should obey MDL this table:

model	≤9000Btu (≤2500W)	≤12000Btu (≤3500W)	≤18000Btu (≤5100W)	≤24000Btu (≤7200W)
Specification of connection cables (mm ²)	1.0	1.5	1.5	2.5

☆ Indoor connection

Open the front panel, inset the connection cables from the base of the air-conditioner, connecting to the terminal board in order (according to the graph), using the pressing board to fasten the connection cables.

Wiring diagram of constant speed

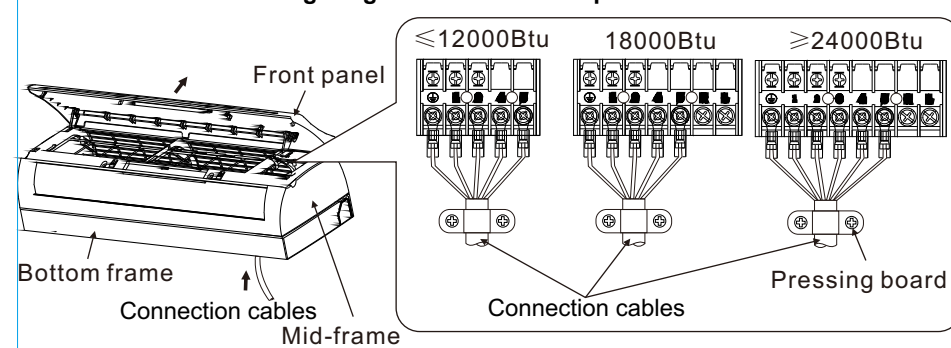

Wiring diagram of variable speed

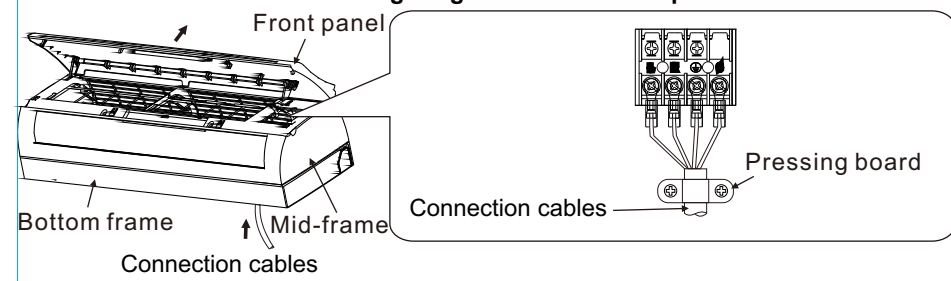

Open the front panel, if the indoor unit is fitted with the signal wire, please detach the mid-frame, and insert the signal wire through the bottom frame, then connect the signal wire quick plug of the indoor's to the outdoor's.

☆ Outdoor connection

- Unscrew the screw, take off the control panel cover from the unit.
- According the connect position of indoor unit, make sure the connection cables connect to the board of outdoor unit corresponding.
- The grounded wire connection:
 1. Loosen the grounded screw of electric bracket.
 2. Connect the grounded wire with the grounded screw then setscrew in the "⊕" mark formerly.
- Fix the cable to the terminal board with pressing board.
- Reinstall the cover with the screw.

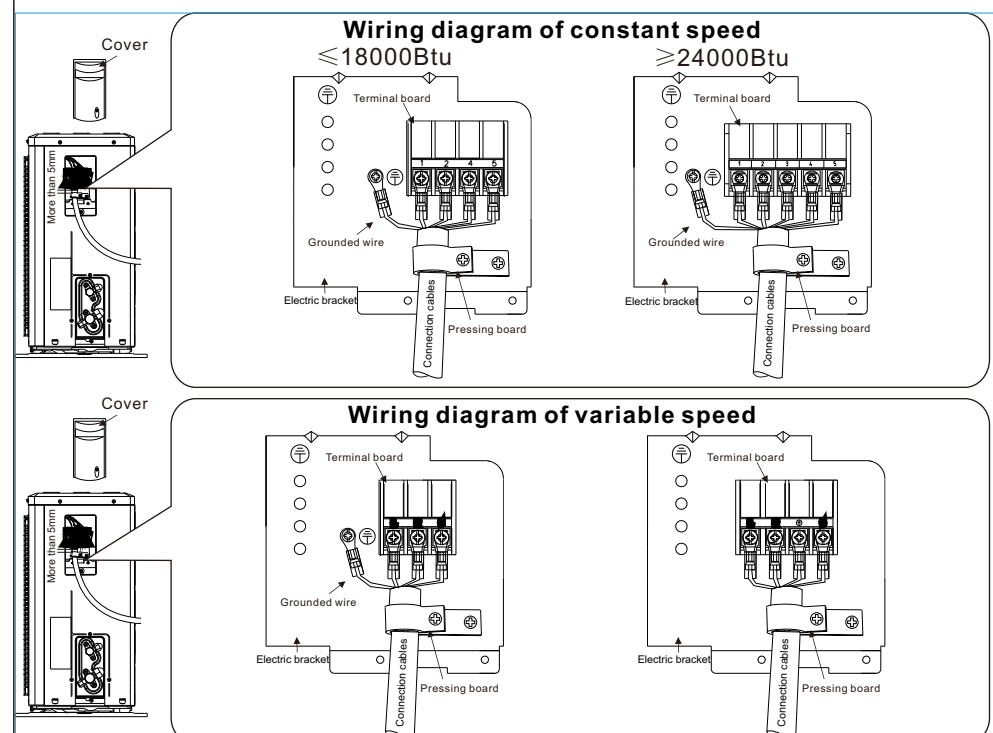

NOTE:
 ※Connect the grounded wire correctly, otherwise will cause the malfunction of some electrical componet and shock or fire indeed.
 ※Don't reverse the power polarity.
 ※Must fix the screwnail of the firmly wire, then drag the wire lightly, confirmation whether it's firmly.
 ※If there is a connector, connect it directly.

The connection of connection cables of indoor unit and outdoor unit must correspond (from the graph in down), otherwise, it could be cause shock or fire.

Wiring diagram of constant speed		Wiring diagram of variable speed	
Heat pump Type		Cold wind Type	
≤12000Btu	18000Btu	≤12000Btu	18000Btu
Terminal board of indoor unit			
Terminal board of outdoor unit			

Brown= Live wire
 Blue= Zero line
 Yellow/Green= Grounded wire

Note:
Explanation for the power cord without plug (see below figure):

NOTE:
 This manual is usually includes the wiring mode for the different kind A/C. We cannot exclude the possibility that some special type of wiring diagrams are not included . please refer to the detailed wiring diagram which is adhered on the back of the panel of indoor unit and E-parts cover of outdoor unit when wiring.

Test running

- Make sure that pipes and wires are connected.
- Make sure that liquid side valve and air side valve both are completely open.

1. The connection of power source

- Connect the wire to independent power source socket.
- Preparation of remote controller.
- Run the air-conditioner in cooling operation mode for 30 minutes or longer.

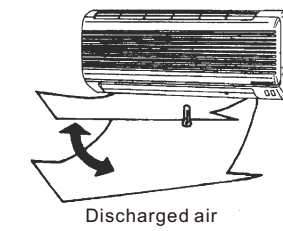

2. Performance evaluation

- Test the out and in air temperature.
- Make sure whether the outlet air temperature subtract from inlet's gives more than 10℃.

Packing list

- Please check the following attach carefully, if part attach isn't useful, please take care of it.

Packing list of the indoor unit

NO.	Name	Unit	Quantity
1	Indoor unit	Set	1
2	Remote controller	PC	1
3	Instructions	PC	1
4	Batteries	PC	2
5	Drain pipe	PC	1

Packing list of the outdoor unit

NO.	Name	Unit	Quantity
1	Outdoor unit	Set	1
2	Connection pipe	PC	2
3	Plastic strap	ROLL	1
4	Pipe protection ring	PC	1
5	Luting (putty)	PACKET	1